



**High Performance Cutting Tools**



**CARBON STEEL HAND TAPS**



## CARBON STEEL HAND TAPS

THREAD FORM	BLANK STANDARD	TOLERANCE	CHAMFER	PAGE
M	BS 949	Zone 5	T/S/B	7.003
MF	BS 949	Zone 5	T/S/B	7.005
BSW	BS 949	Zone 5	T/S/B	7.007
BSF	BS 949	Zone 5	T/S/B	7.009
BA	BS 949	Zone 5	T/S/B	7.010
BSB	BS 949	Zone 5	T/S/B	7.011
BS Con	BS 949	Zone 5	T/B	7.012
ME	BS 949	Zone 5	T/S/B	7.013
BS Cy	BS 949	Zone 5	T/S/B	7.014
WF	BS 949	Zone 5	T/S/B	7.015
BSP	BS 949	Zone 5	T/B	7.016
BSPT	BS 949	Zone 5	T/B	7.017
UNC	ANSI 94.9	2B	T/S/B	7.018
UNF	ANSI 94.9	2B	T/S/B	7.019
NPT	ANSI 94.9	2B	T/B	7.021
NPS	ANSI 94.9	2B	T/B	7.022
UNS	ANSI 94.9	2B	T/S/B	7.023

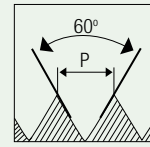

**Metric coarse threads**

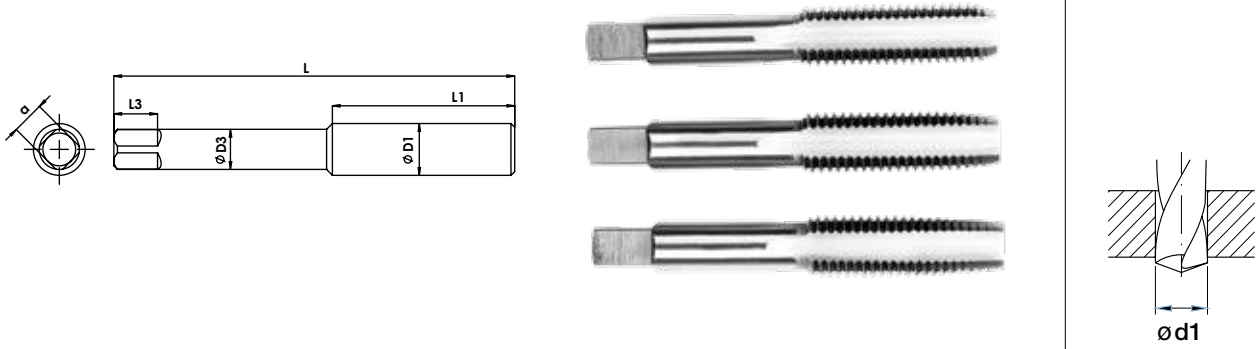
**HOLE TYPE**

**CS**
**BS  
949**
**ZONE  
5**

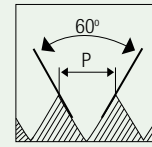

								Unit : mm
Nominal Diameter	Pitch	Overall Length	Thread Length	Shank Diameter	Square Size	Square Length	Tapping Drill Diameter	EDP No.
ØD1	p	L	L1	ØD3	a	L3	Ø d1	
M 2	0.4	44.03	11.5	3.25	2.58	4.46	1.6	FBA0204977
M 2.2	0.45	45.72	15	3.25	2.58	4.46	1.75	FBA0205005
M 2.5	0.45	47.51	15	3.25	2.58	4.46	2.05	FBA0205061
M 3	0.5	49.4	17	3.25	2.58	4.46	2.5	FBA0205117
M 3.5	0.6	52.85	20.6	3.66	2.86	4.46	2.9	FBA0205174
M 4	0.7	56.33	22.5	4.22	3.26	6.05	3.3	FBA0205231
M 4.5	0.75	62.99	26.6	4.8	3.69	6.05	3.7	FBA0205318
M 5	0.8	63.29	26.6	5.41	4.15	6.05	4.2	FBA0205404
M 6	1	67.04	30.7	6.15	4.71	6.84	5	FBA0205632
M 7	1	67.68	30.7	7.21	5.5	7.64	6	FBA0205716
M 8	1.25	69.85	30.5	8.2	6.23	8.43	6.8	FBA0205831
M 9	1.25	74.61	33.7	9.12	6.9	10.02	7.8	FBA0205943
M 10	1.5	74.61	33.7	10.29	7.73	10.02	8.5	FBA0206091
M 11	1.5	80.17	36.5	8.2	6.06	10.02	9.5	FBA0206204
M 12	1.5	85.83	42.1	9.32	6.9	10.81	10.5	FBA0206324
M 12	1.75	85.83	42.1	9.32	6.9	10.81	10.2	FBA0206356
M 14	1.5	91.28	42	10.91	8.07	12.4	12.5	FBA0206529
M 14	2	91.28	42	10.91	8.07	12.4	12	FBA0206560

**M**

**Metric coarse threads**

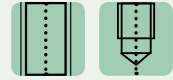

HOLE TYPE



**CS**

**BS 949**

**ZONE 5**

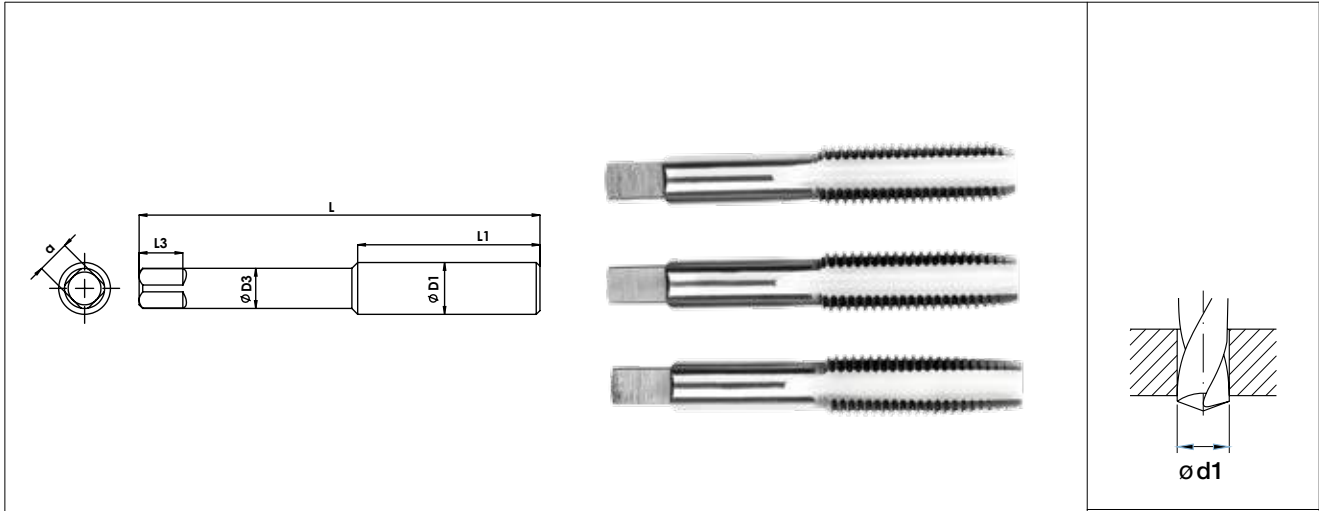

Unit : mm

Nominal Diameter	Pitch	Overall Length	Thread Length	Shank Diameter	Square Size	Square Length	Tapping Drill Diameter	EDP No.
ØD1	p	L	L1	ØD3	a	L3	Ø d1	
M 16	2	96.84	46	12.2	9.04	13.99	14	FBA0206759
M 18	2.5	102.4	46	13.78	10.2	15.58	15.5	FBA0206986
M 20	2.5	107.95	50.8	15	11.12	17.16	17.5	FBA0207100
M 22	2.5	119.06	56.4	17.71	13.17	18.75	19.5	FBA0207215
M 24	3	124.62	56.35	19.31	14.37	18.75	21	FBA0207359
M 27	3	129.8	63.5	20.35	15.13	20.2	24	FBA0207559
M 30	3.5	137.8	65	22.79	16.96	21.9	26.5	FBA0207815
M 33	3.5	145.8	65	25.98	19.34	25.2	29.5	FBA0208015
M 36	4	153.8	76	28.17	20.99	26.7	32	FBA0208155
M 39	4	161.8	76	31.35	23.38	28.2	35	FBA0208211
M 42	4.5	169.8	81	33.18	24.75	28.2	37.5	FBA0208295
M 45	4.5	177.8	81	36.35	27.12	31.7	40.5	FBA0208323
M 48	5	185.3	90.5	38.61	28.82	31.7	43	FBA0208351
M 52	5	193.3	90.5	38.61	28.82	31.7	47	FBA0208407

**MF**

**Metric fine threads**

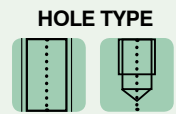
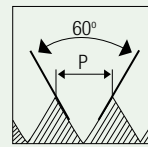



CS

BS  
949

ZONE  
5

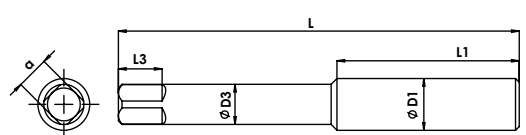

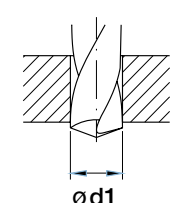
  								Unit : mm
Nominal Diameter	Pitch	Overall Length	Thread Length	Shank Diameter	Square Size	Square Length	Tapping Drill Diameter	EDP No.
ØD1	p	L	L1	ØD3	a	L3	Ø d1	
M 2.3	0.4	45.81	15.00	3.25	2.58	4.46	1.9	FBA0205033
M 2.6	0.45	49.16	17.00	3.25	2.58	4.46	2.1	FBA0205089
M 3	0.6	49.36	17.00	3.25	2.58	4.46	2.4	FBA0205146
M 4	0.5	56.33	22.50	4.22	3.26	6.05	3.5	FBA0205202
M 4	0.75	56.33	22.50	4.22	3.26	6.05	3.25	FBA0205259
M 5	0.5	63.29	26.60	5.41	4.15	6.05	4.5	FBA0205346
M 5	0.9	63.29	26.60	5.41	4.15	6.05	4.1	FBA0205432
M 5.5	0.9	63.58	26.60	5.61	4.30	6.05	4.6	FBA0205517
M 6	0.75	67.13	30.70	6.15	4.71	6.84	5.2	FBA0205573
M 8	0.75	69.85	30.50	8.20	6.23	8.43	7.2	FBA0205772
M 8	1	69.85	30.50	8.20	6.23	8.43	7	FBA0205800
M 9	1	74.61	33.70	9.12	6.90	10.02	8	FBA0205915
M 10	0.75	74.61	33.70	10.29	7.73	10.02	9.2	FBA0205999
M 10	1	74.61	33.70	10.29	7.73	10.02	9	FBA0206027
M 10	1.25	74.61	33.70	10.29	7.73	10.02	8.8	FBA0206059
M 12	1	76.20	31.75	9.32	6.90	10.81	11	FBA0206260
M 12	1.25	76.20	31.75	9.32	6.90	10.81	10.75	FBA0206292
M 14	1.25	76.20	31.75	10.91	8.07	12.40	12.75	FBA0206497

CS TAPS



## Carbon Steel Hand Taps

# MF

## Metric fine threads

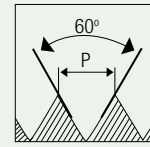

HOLE TYPE

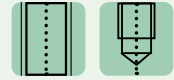

CS

BS  
949

ZONE  
5



								EDP No.
Nominal Diameter	Pitch	Overall Length	Thread Length	Shank Diameter	Square Size	Square Length	Tapping Drill Diameter	
ØD1	p	L	L1	ØD3	a	L3	Ø d1	Unit : mm
M 16	1	76.20	31.75	12.20	9.04	13.99	15	FBA0206672
M 18	1.5	76.20	31.75	13.78	10.20	15.58	16.5	FBA0206927
M 20	1	82.55	38.10	15.00	11.12	17.16	19	FBA0207014
M 22	1.5	82.55	38.10	17.71	13.17	18.75	20.5	FBA0207156
M 24	1.5	82.55	38.10	19.31	14.37	18.75	22.5	FBA0207271
M 25	1.5	82.55	38.10	20.33	15.13	20.34	23.5	FBA0207387
M 26	1.5	82.35	38.10	20.35	15.13	20.20	24.5	FBA0207445
M 27	1.5	82.35	38.10	20.35	15.13	20.20	25.5	FBA0207501
M 28	1.5	101.40	38.10	21.21	15.77	20.30	26.5	FBA0207615
M 30	1.5	101.40	38.10	22.79	16.96	21.90	28.5	FBA0207700
M 30	2	101.40	38.10	22.79	16.96	21.90	28	FBA0207729
M 32	1.5	101.40	38.10	25.98	19.34	25.20	31.5	FBA0207871
M 40	1.5	101.40	38.10	31.35	23.38	28.20	38	FBA0208239

CS TAPS

**BSW**

**Whitworth coarse threads**

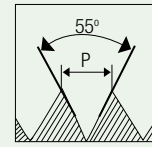

HOLE TYPE



CS

BS  
949

ZONE  
5

T/S/B

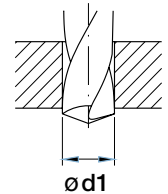
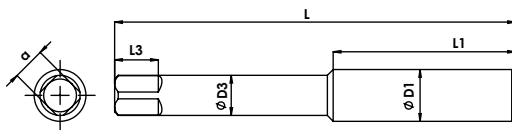

Unit : mm

Nominal Diameter	TPI	Overall Length	Thread Length	Shank Diameter	Square Size	Square Length	Tapping Drill Diameter	EDP No.
ØD1		L	L1	ØD3	a	L3	Ø d1	
1/16"	60	42.19	10.5	3.25	2.58	4.46	-	FBA0200001
3/32"	48	47.41	15	3.25	2.58	4.46	-	FBA0200029
1/8"	40	51.05	18.8	3.25	2.58	4.46	-	FBA0200057
5/32"	32	56.28	22.3	4.04	3.03	6.05	-	FBA0200085
3/16"	24	63.04	26.6	4.8	3.69	6.05	3.7	FBA0200113
7/32"	24	63.56	26.6	5.61	4.3	6.05	4.5	FBA0200141
1/4"	20	67.17	30.7	6.43	4.91	6.84	5.1	FBA0200169
9/32"	20	67.68	30.7	7.21	5.5	7.64	5.8	FBA0200197
5/16"	18	69.85	30.5	8	6.06	8.43	6.5	FBA0200225
3/8"	16	74.61	33.7	9.58	7.38	10.02	7.9	FBA0200253
7/16"	14	80.17	36.5	8.2	6.06	10.02	9.3	FBA0200281
1/2"	12	85.83	42.1	9.32	6.9	10.81	10.5	FBA0200309
9/16"	12	91.28	42	10.91	8.07	12.4	12.1	FBA0200338
5/8"	11	96.84	46	12.2	9.04	13.99	13.5	FBA0200366
11/16"	11	102.4	46	13.78	10.2	15.58	15	FBA0200394

**BSW**

**Whitworth coarse threads**

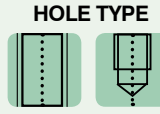
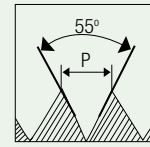

CS    BS 949    ZONE 5    T/S/B

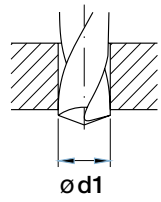
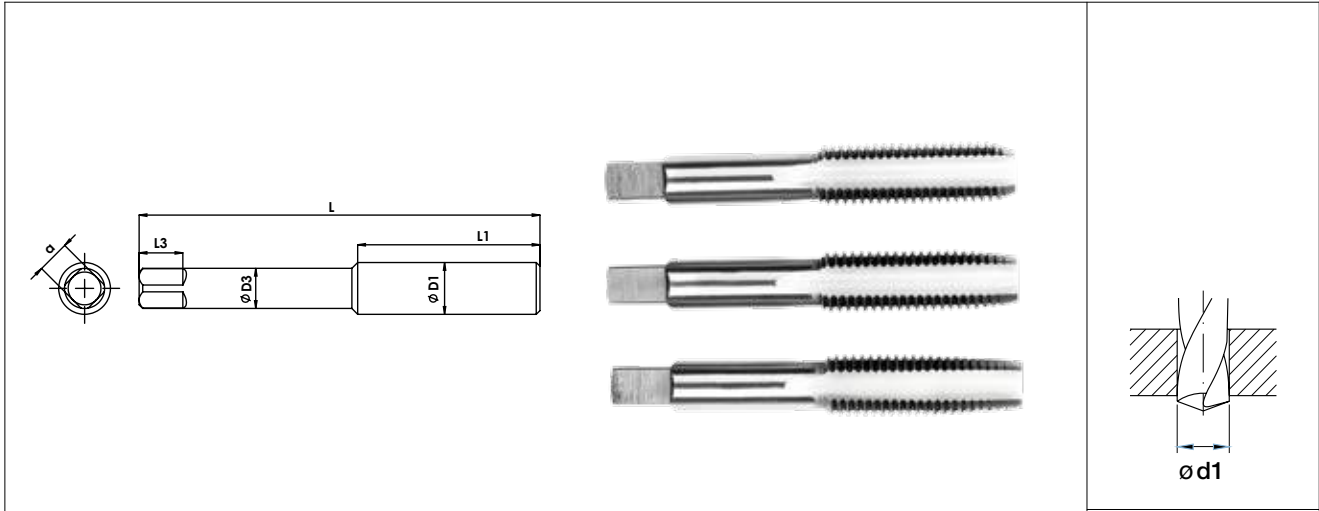

Unit : mm

Nominal Diameter	TPI	Overall Length	Thread Length	Shank Diameter	Square Size	Square Length	Tapping Drill Diameter	EDP No.
ØD1		L	L1	ØD3	a	L3	Ø d1	
3/4"	10	107.95	50.8	15	11.12	17.16	16.25	FBA0200422
7/8"	9	119.06	56.4	17.71	13.18	18.75	19.25	FBA0200478
1"	8	130.18	63.5	20.33	15.13	20.34	22	FBA0200534
1.1/8"	7	137.8	65	22.79	16.96	21.7	24.75	FBA0200562
1.1/4"	7	145.8	65	25.96	19.34	25.2	28	FBA0200590
1.3/8"	6	153.8	76	28.17	20.99	26.7	31	FBA0200618
1.1/2"	6	161.8	76	31.35	23.38	28.2	33.5	FBA0200646
1.3/4"	5	177.8	81	36.35	27.12	31.7	39	FBA0200702
2"	4.5	193.3	90.5	41.79	31.21	34.7	44.5	FBA0200758

CS TAPS



**BSF**

**Whitworth fine threads**

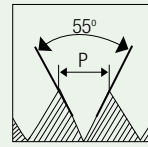

HOLE TYPE



CS

BS  
949

ZONE  
5



Nominal Diameter	TPI	Overall Length	Thread Length	Shank Diameter	Square Size	Square Length	Tapping Drill Diameter	EDP No.
ØD1		L	L1	ØD3	a	L3	Ø d1	
3/16"	32	63.15	26.6	4.8	3.69	6.05	4	FBA0200842
7/32"	28	63.61	26.6	5.61	4.3	6.05	4.6	FBA0200870
1/4"	26	67.27	30.7	6.43	4.91	6.84	5.3	FBA0200898
9/32"	26	67.79	30.7	7.21	5.5	7.64	6.1	FBA0200926
5/16"	22	69.85	30.5	8	6.06	8.43	6.8	FBA0200954
3/8"	20	74.61	33.7	9.58	7.38	10.02	8.3	FBA0200982
7/16"	18	80.17	36.5	8.2	6.06	10.02	9.7	FBA0201011
1/2"	16	85.83	42.1	9.32	6.9	10.81	11.1	FBA0201039
9/16"	16	91.28	42	10.91	8.07	12.4	12.7	FBA0201067
5/8"	14	96.84	46	12.2	9.04	13.99	14	FBA0201095
11/16"	14	102.4	46	13.78	10.19	15.58	15.5	FBA0201123
3/4"	12	107.95	50.8	15	11.12	17.16	16.75	FBA0201151
7/8"	11	119.06	56.4	17.71	13.18	18.75	19.75	FBA0201207
1"	10	130.18	63.5	20.33	15.13	20.34	22.75	FBA0201263
1.1/8"	9	137.8	65	22.79	16.96	21.7	25.5	FBA0201291
1.1/4"	9	145.8	65	25.96	19.34	25.2	28.5	FBA0201319
1.3/8"	8	153.8	76	28.17	20.99	26.7	31.5	FBA0201347
1.1/2"	8	161.8	76	31.35	23.38	28.2	34.5	FBA0201375

Unit : mm

CS TAPS

**BA**

**British association threads**

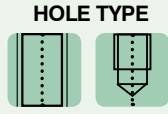
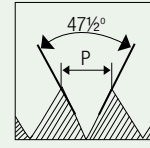

CS
BS 949
ZONE 5
T/S/B

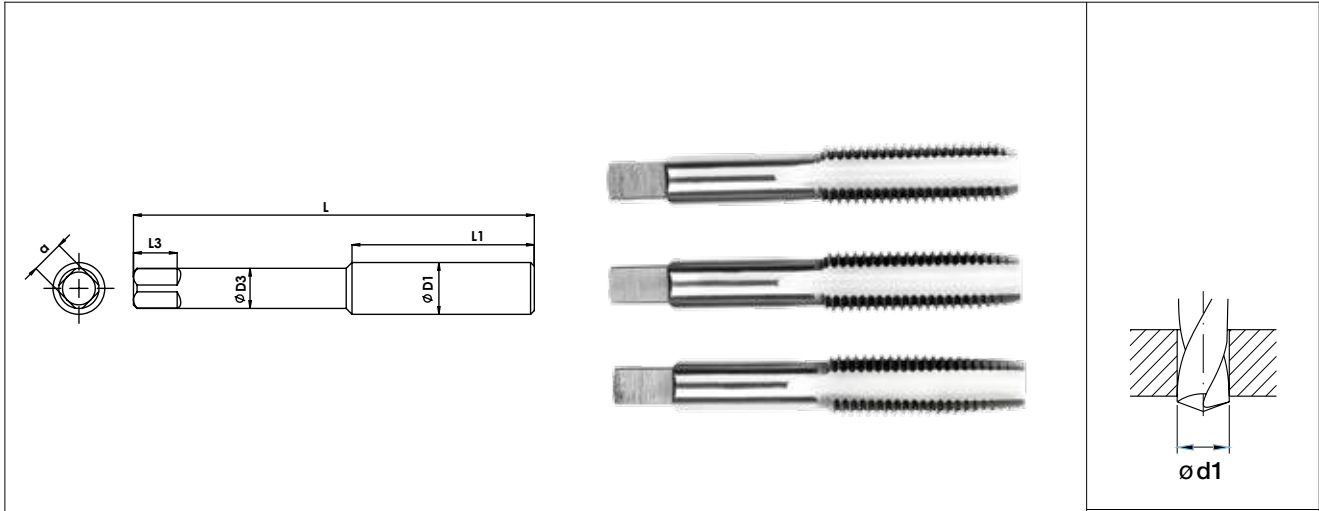

Unit : mm

Nominal Diameter	p	Overall Length	Thread Length	Shank Diameter	Square Size	Square Length	Tapping Drill Diameter	EDP No.
ØD1		L	L1	ØD3	a	L3	Ø d1	
# 12	0.28	42.00	10.50	3.25	2.58	4.46	1.05	FBA0209359
# 11	0.31	42.08	10.50	3.25	2.58	4.46	1.2	FBA0209387
# 10	0.35	42.29	11.50	3.25	2.58	4.46	1.4	FBA0209415
# 9	0.39	43.98	11.50	3.25	2.58	4.46	1.55	FBA0209443
# 8	0.43	45.76	15.00	3.25	2.58	4.46	1.8	FBA0209471
# 7	0.48	47.52	15.00	3.25	2.58	4.46	2.05	FBA0209499
# 6	0.53	49.29	17.00	3.25	2.58	4.46	2.3	FBA0209527
# 5	0.59	51.11	18.80	3.25	2.58	4.46	2.65	FBA0209555
# 4	0.66	52.92	20.60	3.66	2.86	4.46	3	FBA0209583
# 3	0.73	56.42	22.50	4.22	3.26	6.05	3.4	FBA0209611
# 2	0.81	63.13	26.60	4.80	3.69	6.05	4	FBA0209639
# 1	0.9	63.47	26.60	5.41	4.15	6.05	4.5	FBA0209667
# 0	1	67.07	30.70	6.15	4.71	6.84	5.1	FBA0209695

CS TAPS



**Carbon Steel Hand Taps**

**BSB**

**British brass threads**

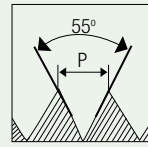

**HOLE TYPE**



**CS**

**BS  
949**

**ZONE  
5**

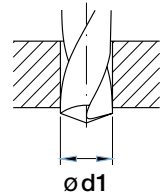
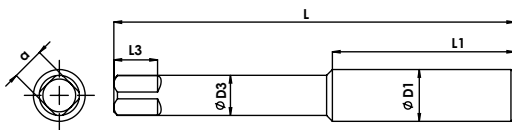

Unit : mm

Nominal Diameter	TPI	Overall Length	Thread Length	Shank Diameter	Square Size	Square Length	Tapping Drill Diameter	EDP No.
ØD1		L	L1	ØD3	a	L3	Ø d1	
1/4"	26	67.27	30.7	6.43	4.91	6.84	5.3	FBA0201487
5/16"	26	69.85	30.5	8	6.06	8.43	6.9	FBA0201515
3/8"	26	74.61	33.7	9.58	7.38	10.02	8.4	FBA0201543
7/16"	26	76.2	31.75	8.2	6.06	10.02	9.9	FBA0201571
1/2"	26	76.2	31.75	9.32	6.9	10.81	11.5	FBA0201599
9/16"	26	76.2	31.75	10.91	8.07	12.4	13.1	FBA0201627
5/8"	26	76.2	31.75	12.2	9.04	13.99	14.65	FBA0201655
3/4"	26	82.55	38.1	15	11.12	17.16	17.86	FBA0201683
1"	26	82.55	38.1	20.33	15.13	20.34	17.86	FBA0201711

**CS TAPS**



**Carbon Steel Hand Taps**

**BS Con**

**British conduit threads**

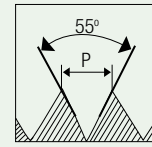

HOLE TYPE



CS    BS 949    ZONE 5    T/B

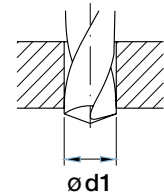
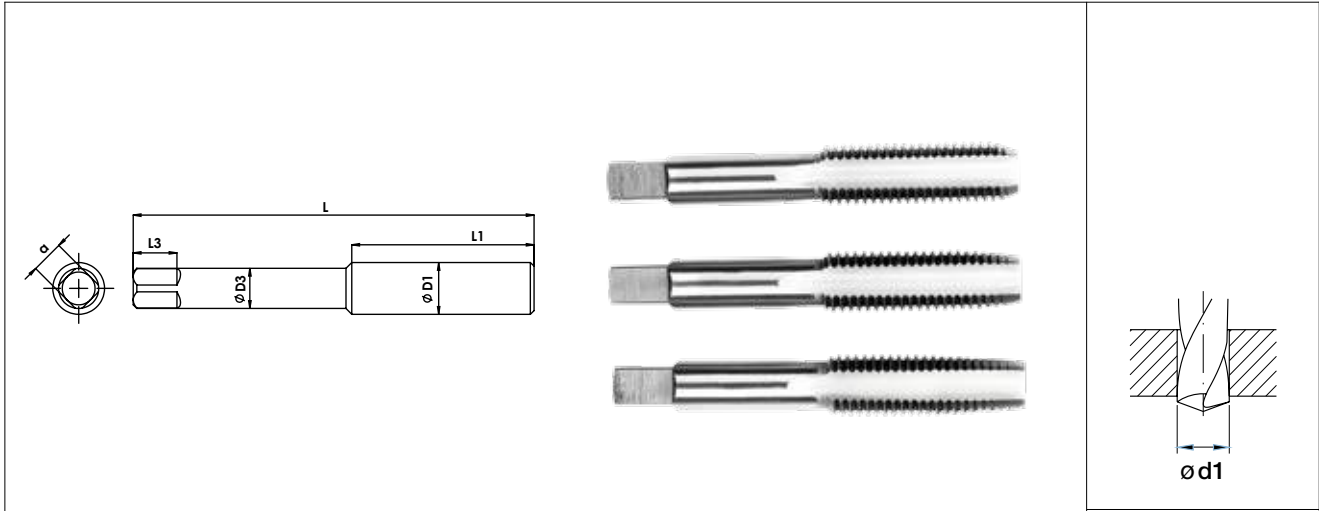

Unit : mm

Nominal Diameter	TPI	Overall Length	Thread Length	Shank Diameter	Square Size	Square Length	Tapping Drill Diameter	EDP No.
ØD1		L	L1	ØD3	a	L3	Ø d1	
1/2"	18	76.2	31.75	9.32	6.9	10.81	11.1	FBA0209023
5/8"	18	76.2	31.75	12.2	9.04	13.99	14	FBA0209051
3/4"	16	82.55	38.1	15	11.12	17.16	17.5	FBA0209079
1"	16	82.55	38.1	20.33	15.13	20.34	23.5	FBA0209107



Model engineer threads

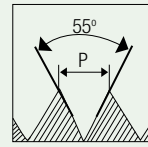

HOLE TYPE





CS

BS  
949

ZONE  
5

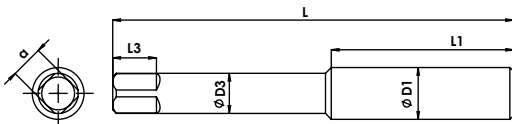





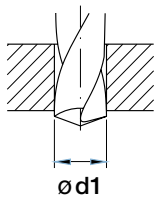

Ød1

								Unit : mm
Nominal Diameter	TPI	Overall Length	Thread Length	Shank Diameter	Square Size	Square Length	Tapping Drill Diameter	EDP No.
ØD1		L	L1	ØD3	a	L3	Ø d1	
1/8"	40	51.05	18.8	3.25	2.58	4.46	2.55	FBA0203295
5/32"	40	56.34	22.5	4.04	3.03	6.05	3.25	FBA0203323
3/16"	40	63.21	26.6	4.8	3.69	6.05	4.1	FBA0203351
7/32"	40	63.73	26.6	5.61	4.3	6.05	4.9	FBA0203379
1/4"	40	67.4	30.7	6.43	4.91	6.84	5.8	FBA0203407
9/32"	32	67.87	30.7	7.21	5.5	7.64	6.1	FBA0203435
5/16"	32	69.85	30.5	8	6.06	8.43	7.1	FBA0203463
3/8"	32	74.61	33.7	9.58	7.38	10.02	8.6	FBA0203491



**Carbon Steel Hand Taps**

**BS Cy**

**British cycle threads**

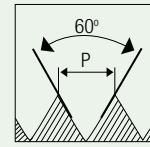

**HOLE TYPE**

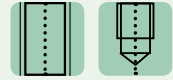

**CS**

**BS 949**

**ZONE 5**

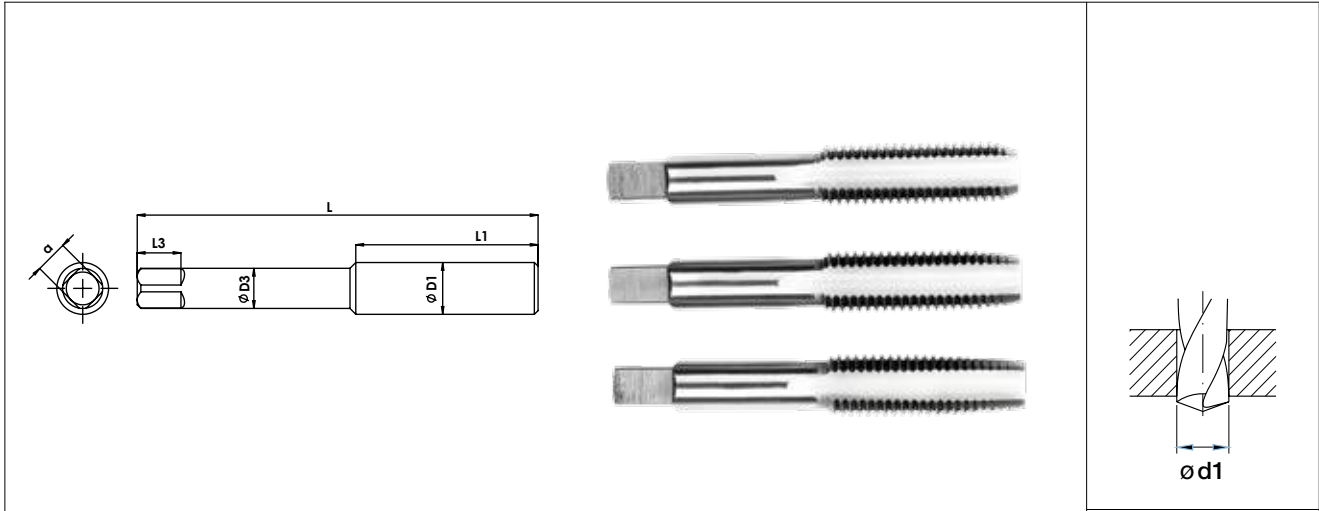

Unit : mm

Nominal Diameter	TPI	Overall Length	Thread Length	Shank Diameter	Square Size	Square Length	Tapping Drill Diameter	EDP No.
Ø D1		L	L1	Ø D3	a	L3	Ø d1	
3/16"	32	63.21	26.6	4.8	3.69	6.05	4.1	FBA0208435
1/4"	26	67.36	30.7	6.43	4.91	6.84	5.6	FBA0208491
5/16"	26	69.85	30.5	8	6.06	8.43	7.1	FBA0208519
3/8"	26	74.61	33.7	9.58	7.38	10.02	8.7	FBA0208547
7/16"	26	76.2	31.75	8.2	6.06	10.02	10.3	FBA0208575
1/2"	26	76.2	31.75	9.32	6.9	10.81	11.9	FBA0208603

**CS TAPS**

**WF**

**Whitworth fine threads special**

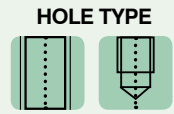
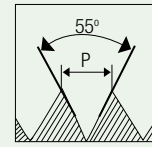

CS

BS 949

ZONE 5

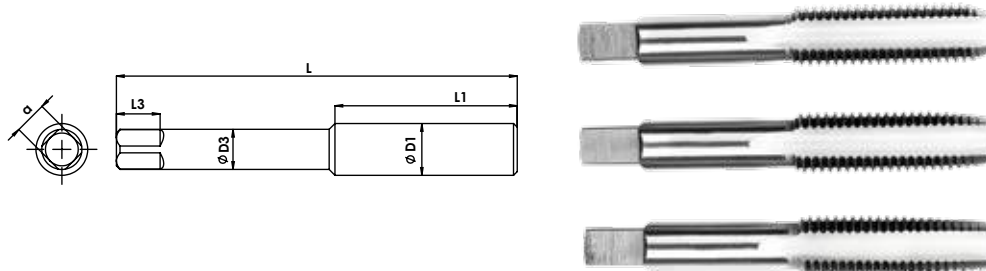
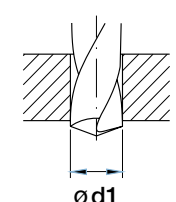

								
								Unit : mm
Nominal Diameter	TPI	Overall Length	Thread Length	Shank Diameter	Square Size	Square Length	Tapping Drill Diameter	EDP No.
ØD1		L	L1	ØD3	a	L3	Ø d1	
3/16"	28	63.1	26.6	4.8	3.69	6.05	-	FBA0204641
7/32"	32	63.73	26.6	5.61	4.3	6.05	-	FBA0204669
1/4"	32	67.36	30.7	6.43	4.91	6.84	5.6	FBA0204697
5/16"	40	69.85	30.5	8	6.06	8.43	7.3	FBA0204753
3/8"	40	74.61	33.7	9.58	7.38	10.02	8.9	FBA0204809
7/16"	40	76.2	31.75	8.2	6.06	10.02	-	FBA0204837
7/16"	32	76.2	31.75	8.2	6.06	10.02	-	FBA0204865
1/2"	40	76.2	31.75	9.32	6.9	10.81	-	FBA0204893
1/2"	32	76.2	31.75	9.32	6.9	10.81	-	FBA0204921
11/64"	40	62.95	26.60	4.80	3.76	6.35	-	FBA0204473
11/64"	48	63	26.60	4.80	3.76	6.35	-	FBA0204501
15/64"	28	67.04	30.70	6.15	4.78	7.14	-	FBA0204585
15/64"	40	67.18	30.70	6.15	4.78	7.14	-	FBA0204613



CS TAPS

# BSP

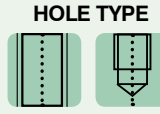
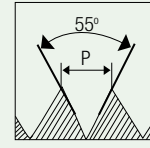
## British standard pipe threads

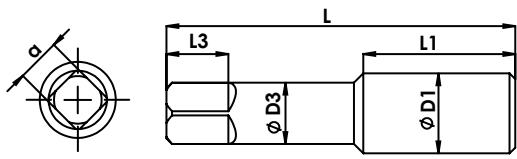

CS
BS 949
ZONE 5
T/B

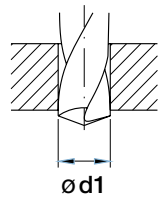
Unit : mm

Nominal Diameter	TPI	Overall Length	Thread Length	Shank Diameter	Square Size	Square Length	Tapping Drill Diameter	EDP No.
ØD1		L	L1	ØD3	a	L3	Ø d1	
1/8"	28	53.98	19.05	8.08	5.96	7.64	8.8	FBA0208631
1/4"	19	61.91	26.99	10.91	8.07	10.81	11.8	FBA0208659
3/8"	19	65.09	26.99	13.78	10.2	12.4	15.25	FBA0208687
1/2"	14	79.38	34.92	17.46	12.97	15.58	19	FBA0208715
5/8"	14	80.96	34.92	20.33	15.13	17.16	21	FBA0208743
3/4"	14	82.55	34.92	22.99	17.14	17.16	24.5	FBA0208771
7/8"	14	88.9	39.69	27.74	20.51	18.75	28.25	FBA0208799
1"	11	95.25	44.45	28.56	21.3	20.34	30.75	FBA0208827
1.1/4"	11	101.3	44.5	33.35	24.88	23.7	39.5	FBA0208883
1.1/2"	11	107.8	44.5	38.13	28.46	25.2	45	FBA0208939
1.3/4"	11	110.8	44.5	41.3	30.82	26.7	51	FBA0208967
2"	11	114.3	44.5	47.65	35.54	28.2	57	FBA0208995



**BSPT**

**British standard taper pipe threads**

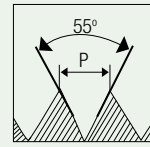

HOLE TYPE



CS

BS  
949

ZONE  
5

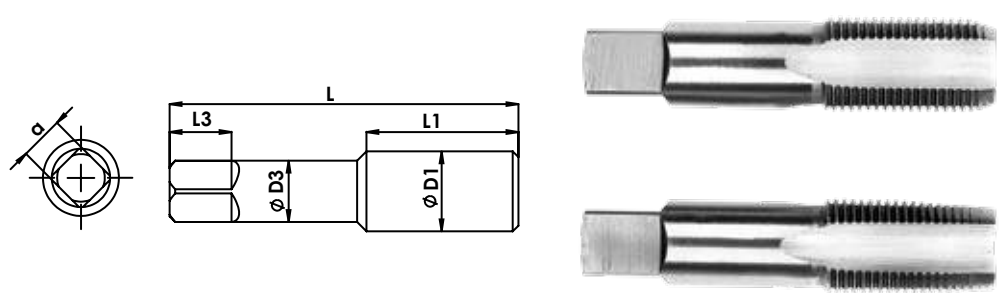
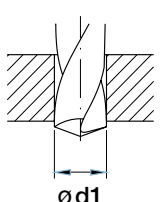

								
								Unit : mm
Nominal Diameter	TPI	Overall Length	Thread Length	Shank Diameter	Square Size	Square Length	Tapping Drill Diameter	EDP No.
ØD1		L	L1	ØD3	a	L3	Ød1	
1/8"	28	54	19.1	8.08	6.05	7.9	8.4	FBA0209135
1/4"	19	61.9	27	10.9	8.18	11.1	11.5	FBA0209163
3/8"	19	65.1	27	13.77	10.31	12.7	14.75	FBA0209191
1/2"	14	79.4	34.9	17.45	13.08	15.9	18.25	FBA0209219
5/8"	14	81	34.9	20.32	15.24	17.5	20.25	FBA0211009
3/4"	14	82.6	34.9	23.01	17.25	17.5	23.4	FBA0209247
1"	11	95.3	44.5	28.58	21.41	20.6	29.75	FBA0209275
1.1/4"	11	101.6	44.5	33.32	24.99	23.8	38.1	FBA0209303
1.1/2"	11	108	44.5	38.1	28.58	25.4	44.5	FBA0209331
2"	11	114.3	44.5	47.63	35.71	28.6	56.4	FBA0211037

# UNC Unified coarse threads

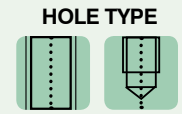
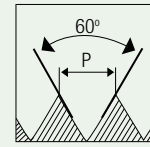

CS
BS 949
2B
T/S/B

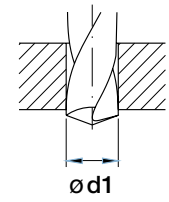
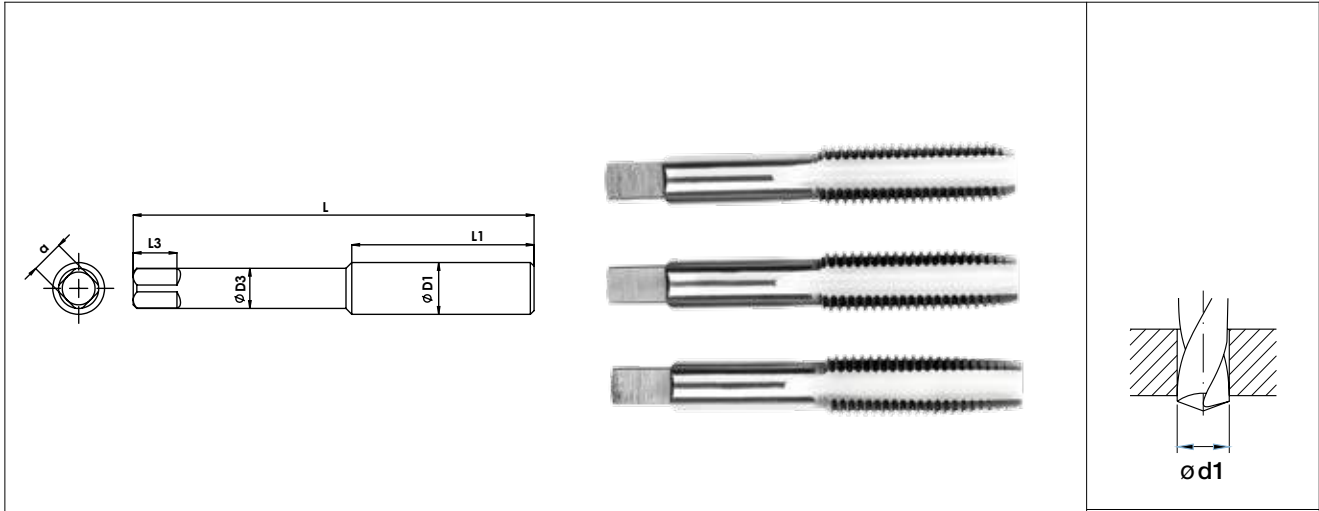

Unit : mm

Nominal Diameter	TPI	Overall Length	Thread Length	Shank Diameter	Square Size	Square Length	Tapping Drill Diameter	EDP No.
ØD1		L	L1	ØD3	a	L3	Ø d1	
# 4	40	49.26	17	3.58	2.7	4.46	2.35	FBA0202566
# 5	40	51.04	18.8	3.58	2.7	4.46	2.65	FBA0202622
# 6	32	52.79	20.6	3.58	2.7	4.46	2.85	FBA0202650
# 8	32	56.39	22.5	4.27	3.24	6.05	3.5	FBA0202706
# 10	24	63.07	26.6	4.93	3.77	6.05	3.9	FBA0202734
# 12	24	63.5	28.5	5.61	4.1	6.84	4.5	FBA0202790
1/4"	20	67.15	30.7	6.48	4.76	7.64	5.1	FBA0202818
5/16"	18	73.68	35.2	8.08	5.96	9.23	6.6	FBA0202846
3/8"	16	74.61	33.7	9.68	7.17	10.81	8	FBA0202874
7/16"	14	80.17	36.5	8.2	6.06	10.02	9.4	FBA0202902
1/2"	13	85.83	42.1	9.32	6.9	10.81	10.8	FBA0202930
9/16"	12	91.28	42	10.91	8.07	12.4	12.2	FBA0202958
5/8"	11	96.84	46	12.2	9.04	13.99	13.5	FBA0202986
3/4"	10	107.95	50.8	15	11.12	17.16	16.5	FBA0203042
7/8"	9	119.06	56.4	17.71	13.18	18.75	19.5	FBA0203070
1"	8	130.18	63.5	20.33	15.13	20.34	22.25	FBA0203098
1.1/8"	7	137.8	65	22.79	16.96	21.7	25	FBA0203126
1.1/4"	7	145.8	65	25.96	19.34	25.2	28	FBA0203155
1.3/8"	6	153.8	76	28.17	20.99	26.7	30.75	FBA0203183
1.1/2"	6	161.8	76	31.35	23.38	28.2	34	FBA0203211
1.3/4"	5	177.8	81	36.35	27.12	31.7	39.5	FBA0203239
2"	4.1/2	193.7	90.5	41.79	31.21	34.7	45	FBA0203267

CS TAPS

# UNF Unified fine threads

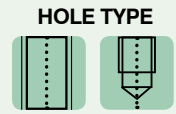
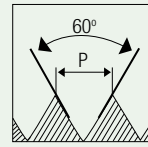

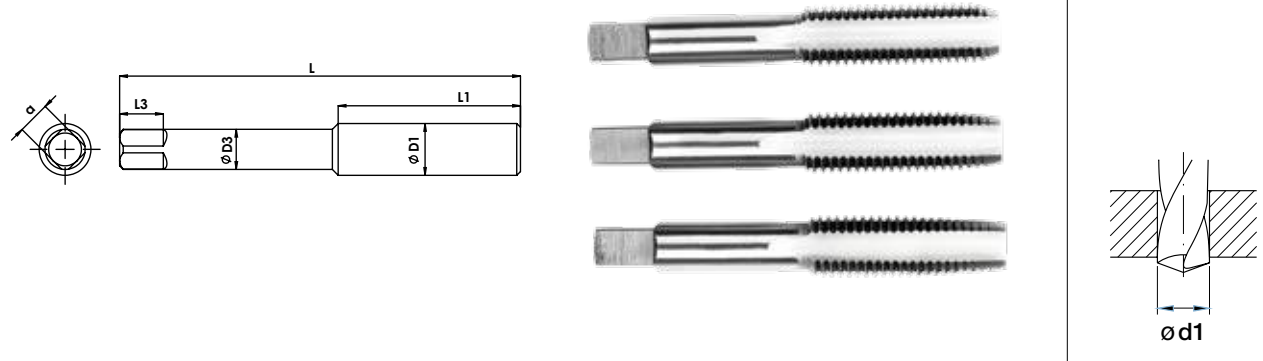
								Unit : mm
Nominal Diameter	TPI	Overall Length	Thread Length	Shank Diameter	Square Size	Square Length	Tapping Drill Diameter	EDP No.
ØD1		L	L1	ØD3	a	L3	Ø d1	
# 5	44	51.06	18.8	3.58	2.7	4.46	2.7	FBA0201879
# 6	40	52.85	20.6	3.58	2.7	4.46	2.95	FBA0201907
# 8	36	56.43	22.5	4.27	3.24	6.05	3.5	FBA0201963
# 10	32	63.17	26.6	4.93	3.77	6.05	4.1	FBA0201991
# 12	28	63.56	28.5	5.61	4.1	6.84	4.7	FBA0202048
1/8"	44	51.06	18.8	3.58	2.7	4.46	-	FBA0201851
5/32"	36	63.13	22.5	4.27	3.24	6.05	-	FBA0201935
3/16"	32	63.13	26.6	4.93	3.77	6.05	-	FBA0202020
1/4"	28	67.28	30.7	6.48	4.76	7.64	5.5	FBA0202077
5/16"	24	73.82	35.2	8.08	5.96	9.23	6.9	FBA0202106
3/8"	24	74.61	33.7	9.68	7.17	10.81	8.5	FBA0202135
7/16"	20	80.17	36.5	8.2	6.06	10.02	9.9	FBA0202164
1/2"	20	85.83	42.1	9.32	6.9	10.81	11.5	FBA0202193
9/16"	18	91.28	42	10.91	8.07	12.4	12.9	FBA0202222
5/8"	18	96.84	46	12.2	9.04	13.99	14.5	FBA0202252
3/4"	16	107.95	50.8	15	11.12	17.16	17.5	FBA0202281

CS TAPS



**Carbon Steel Hand Taps**

**UNF**

**Unified fine threads**

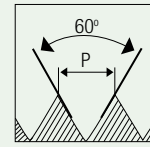

**HOLE TYPE**

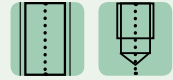

CS
BS 949
2B
T/S/B

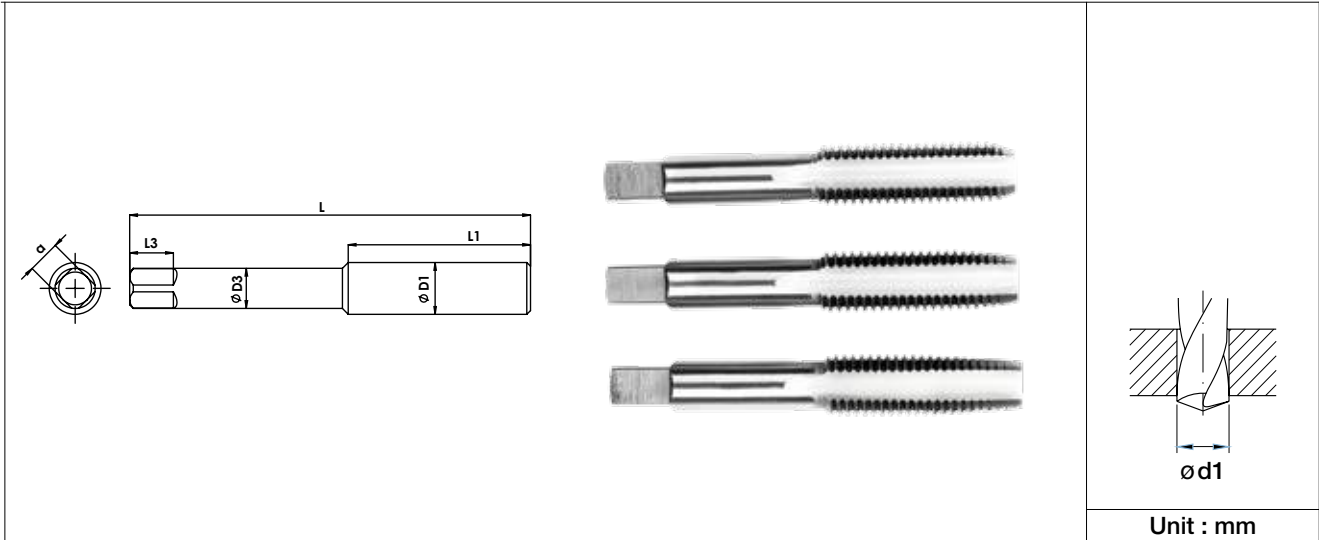

Unit : mm

Nominal Diameter	TPI	Overall Length	Thread Length	Shank Diameter	Square Size	Square Length	Tapping Drill Diameter	EDP No.
ØD1		L	L1	ØD3	a	L3	Ø d1	
7/8"	14	119.06	56.4	17.71	13.18	18.75	20.4	FBA0202310
1"	12	130.18	63.5	20.33	15.13	20.34	23.25	FBA0202339
1.1/8"	12	137.8	65	22.79	16.96	21.7	26.5	FBA0202368
1.1/4"	12	145.8	65	25.96	19.34	25.2	29.5	FBA0202396
1.3/8"	12	153.8	76	28.17	20.99	26.7	32.75	FBA0202425
1.1/2"	12	161.8	76	31.35	23.38	28.2	36	FBA0202454

**CS TAPS**

**NPT**

**American taper pipe threads**

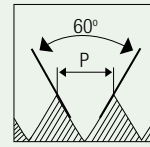

HOLE TYPE



CS

ANSI  
94.9

2B

T/B

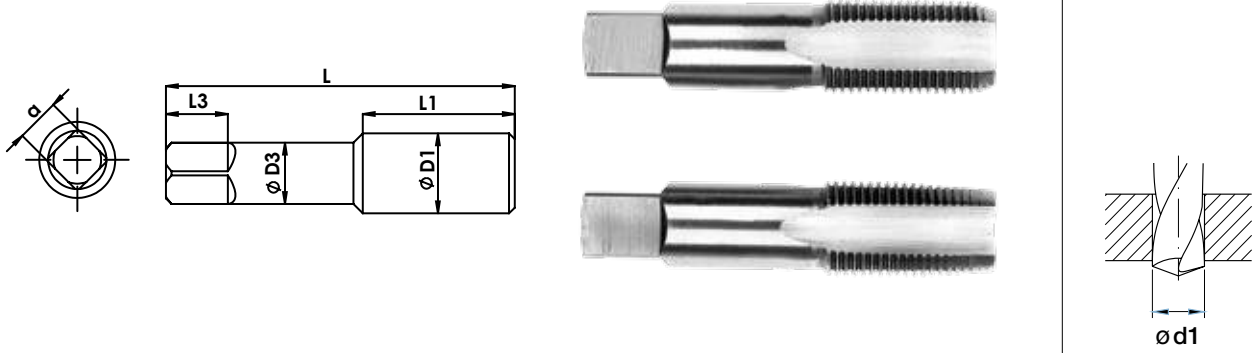
								Unit : mm
Nominal Diameter	TPI	Overall Length	Thread Length	Shank Diameter	Square Size	Square Length	Tapping Drill Diameter	EDP No.
ØD		L	L1	ØD3	a	L3	Ød1	
1/8"	27	54	19.1	8.08	6.05	7.9	8.7	FBA0209891
1/4"	18	61.9	27	10.9	8.18	11.1	11.1	FBA0209919
3/8"	18	65.1	27	13.77	10.31	12.7	14.7	FBA0209947
1/2"	14	79.4	34.9	17.45	13.08	15.9	17.9	FBA0209975
3/4"	14	82.6	34.9	23.01	17.25	17.5	23.4	FBA0210031
1"	11.1/2	95.3	44.5	28.58	21.41	20.6	29.4	FBA0210059
1.1/4"	11.1/2	101.6	44.5	33.32	24.99	23.8	38.1	FBA0210087
1.1/2"	11.1/2	108	44.5	38.1	28.58	25.4	44	FBA0210115
2"	11.1/2	114.3	44.5	47.63	35.71	28.6	56.4	FBA0210143

# NPS

## National pipe threads special

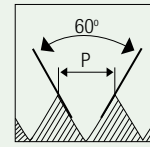

HOLE TYPE

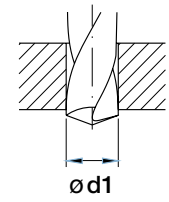
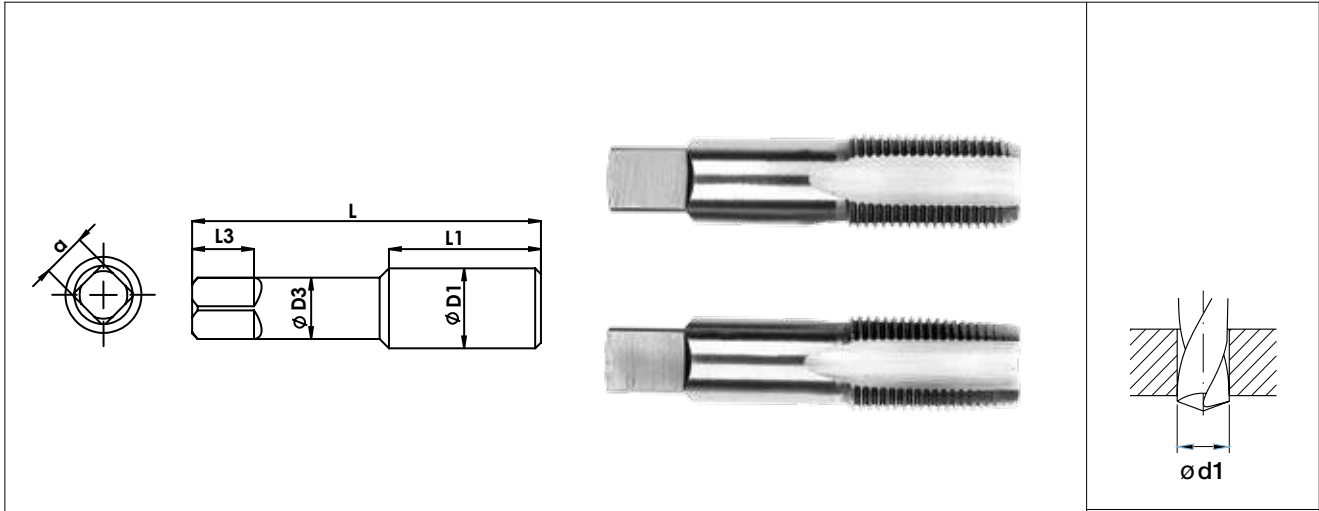

Unit : mm

Nominal Diameter	TPI	Overall Length	Thread Length	Shank Diameter	Square Size	Square Length	Tapping Drill Diameter	EDP No.
ØD1		L	L1	ØD3	a	L3	Ø d1	
1/8"	27	53.97	19.05	8.08	5.96	7.64	9.1	FBA0209723
1/4"	18	61.91	26.98	10.91	8.07	10.81	11.9	FBA0209751
3/8"	18	65.09	26.99	13.78	10.2	12.4	15.25	FBA0209779
1/2"	14	79.38	34.92	17.46	12.97	15.58	19	FBA0209807
3/4"	14	82.55	34.92	22.99	17.14	17.16	27	FBA0209835
1"	11.5	95.25	44.45	28.56	21.3	20.34	30.5	FBA0209863

UNS

Unified threads special

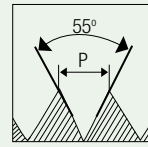

HOLE TYPE



CS

ANSI 949

2B



Nominal Diameter	TPI	Overall Length	Thread Length	Shank Diameter	Square Size	Square Length	Tapping Drill Diameter	EDP No.
ØD1		L	L1	ØD3	a	L3	Ø d1	
1/8"	40	51.04	18.8	3.58	2.7	4.46	-	FBA0203547
5/32"	32	56.26	22.5	4.27	3.24	6.05	3.6	FBA0203631
5/32"	36	56.31	22.5	4.27	3.24	6.05	3.65	FBA0203659
7/32"	24	63.55	28.5	5.61	4.1	6.84	-	FBA0203743
7/32"	28	63.65	28.5	5.61	4.1	6.84	-	FBA0203715
7/32"	32	63.65	28.5	5.61	4.1	6.84	-	FBA0203771
3/16"	24	63.03	26.6	4.93	3.77	6.05	4.25	FBA0203799
3/16"	32	63.13	26.6	4.93	3.77	6.05	4.4	FBA0203829
1/4"	20	67.01	30.7	6.48	4.76	7.64	-	FBA0203857
1/4"	24	67.23	30.7	6.48	4.76	7.64	-	FBA0203885
1/4"	32	67.34	30.7	6.48	4.76	7.64	-	FBA0203913
5/16"	32	73.68	35.2	8.08	5.96	10.02	7.5	FBA0203941
11/16"	11	102.4	46	13.78	10.2	15.58	16.4	FBA0203969
11/16"	16	102.4	46	13.78	10.2	15.58	16.7	FBA0203997
7/8"	12	119.06	56.4	17.71	13.18	18.75	-	FBA0204053
7/8"	18	119.06	56.4	17.71	13.18	18.75	-	FBA0204025
1"	14	130.18	63.5	20.33	15.13	20.34	24.6	FBA0204081
1-1/8"	8	137.8	65	22.79	16.96	21.7	-	FBA0204137

Unit : mm

CS TAPS



**Carbon Steel Hand Taps**

**UNS**

**Unified threads special**

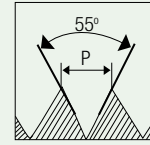

**HOLE TYPE**



CS
ANSI 949
2B
T/S/B

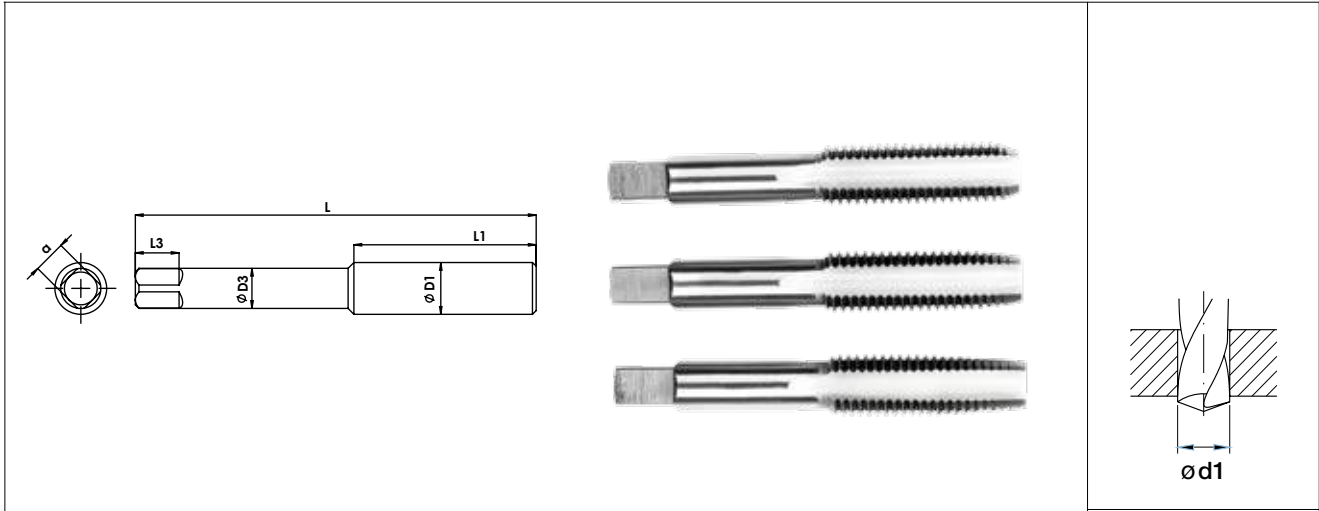

Unit : mm

Nominal Diameter	TPI	Overall Length	Thread Length	Shank Diameter	Square Size	Square Length	Tapping Drill Diameter	EDP No.
ØD1		L	L1	ØD3	a	L3	Ø d1	
1-1/4"	8	145.8	65	25.96	19.34	25.2	-	FBA0204165
1-3/8"	8	153.8	76	28.17	20.99	26.7	-	FBA0204193
1-1/2"	8	161.8	76	31.35	23.38	28.2	-	FBA0204221
1-5/8"	8	169.8	81	33.18	24.75	28.2	-	FBA0204249
1-3/4"	8	177.8	81	36.35	27.12	31.7	-	FBA0204277
1-3/4"	12	177.8	81	36.35	27.12	31.7	-	FBA0204305
1-7/8"	8	185.3	90.5	38.61	28.82	31.7	-	FBA0204333
2"	8	193.3	90.5	41.79	31.21	34.7	-	FBA0204389
2"	12	193.3	90.5	41.79	31.21	34.7	-	FBA0204417

CS TAPS





## Carbon Steel Hand Taps



### Tap and die case sets

Description	EDP No	Content
Ref. No METRIC 1 M6-M20 SECS (20Pc)	FBI0200001	"Taps (Second): M6, M8, M10, M12, M14, M16, M20 Dies: 1" OD- M6 TO M10 & 1.1/2" OD - M12 TO M20 Accessories: Tap Wrenches - 2nos. & Die stock - 2nos."
Ref. No METRIC 2 M6-M20 T&B (28Pc)	FBI0200002	"Taps (Taper & Bottom): M6, M8, M10, M12, M14, M16, M20 Dies: 1" OD- M6 TO M10 & 1.1/2" OD - M12 TO M20 Accessories: Tap Wrenches - 2nos. & Die stock - 2nos."
Ref. No METRIC C119 M6-M20 T&B (37Pc)	FBI0200003	"Taps (Taper & Bottom): M6, M7, M8, M9, M10, M11, M12, M14, M16, M20 Dies: 1" OD- M6 TO M10 & 1.1/2" OD - M11 TO M20 Accessories: Tap Wrenches - 2nos. & Die stock - 2nos."
Ref. No METRIC 3 M3-M10 T&B (21Pc)	FBI0200004	"Taps (Taper & Bottom): M3, M4, M5, M6, M8, M10 Dies: 13/16" OD- M3 TO M5 & 1" OD - M6 TO M10 Accessories: Tap Wrenches - 1no. & Die stock - 2nos."
Ref. No METRIC 4P M2-M6 T&B (17Pc)	FBI0200005	"Taps (Taper & Bottom): M2, M3, M4, M5, M6 Dies: 13/16" OD- M2 TO M6 Accessories: Tap Wrenches - 1no. & Die stock - 1no."
Ref. No METRIC 4S M2-M6 SET (22Pc)	FBI0200006	"Taps (Taper, Second & Bottom): M2, M3, M4, M5, M6 Dies: 13/16" OD- M2 TO M6 Accessories: Tap Wrenches - 1no. & Die stock - 1no."
Ref. No METRIC 5F M6-M24 T&B (35Pc)	FBI0200007	"Taps (Taper & Bottom): MF6, MF8, MF10, MF12, MF14, MF16, MF18, MF20, MF22, MF24 Dies: 1" OD- MF6 TO MF10 & 1.1/2" OD - MF12 TO MF20 & 2" OD -MF22 TO MF24 Accessories: Tap Wrenches - 2nos. & Die stock - 3nos."
Ref. No METRIC C120 M6-M24 T&B (44Pc)	FBI0200008	"Taps (Taper & Bottom): M6, M7, M8, M9, M10, M11, M12, M14, M16, M20, M22, M24 Dies: 1" OD- M6 TO M10 & 1.1/2" OD - M11 TO M16 & 2" OD -M18 TO M24 Accessories: Tap Wrenches - 2nos. & Die stock - 3nos."
Ref. No METRIC 5C M6-M24 T&B (35Pc)	FBI0200009	"Taps (Taper & Bottom): M6, M8, M10, M12, M14, M16, M18, M20, M22, M24 Dies: 1" OD- M6 TO M10 & 1.1/2" OD - M12 TO M20 & 2" OD -M22 TO M24 Accessories: Tap Wrenches - 2nos. & Die stock - 3nos."
Ref. No METRIC 6P M3-M12 T&B (24Pc)	FBI0200010	"Taps (Taper & Bottom): M3, M4, M5, M6, M8, M10, M12 Dies: 1" OD- M3 TO M12 Accessories: Tap Wrenches - 2nos. & Die stock - 1nos."
Ref. No METRIC 6S M3-M12 SET (31Pc)	FBI0200011	"Taps (Taper, Second & Bottom): M3, M4, M5, M6, M8, M10, M12 Dies: 1" OD- M3 TO M12 Accessories: Tap Wrenches - 2nos. & Die stock - 1nos."
Ref. No METRIC C114 M2-M12 T&B (36Pc)	FBI0200012	"Taps (Taper, Second & Bottom): M2, M3, M4, M5, M6, M7, M8, ,M9, M10, M11, M12 Dies: 13/16" OD - M2 TO M6 & 1" OD- M7 TO M12 Accessories: Tap Wrenches - 1nos. & Die stock - 2nos."
Ref. No METRIC 7 M6-M12 T&B (18Pc)	FBI0200013	"Taps (Taper, Second & Bottom): M6, M8, M10, M11, M12 Dies: 1" OD - M6 TO M10 & 1.1/2" OD- M11, M12 Accessories: Tap Wrenches - 1nos. & Die stock - 2nos."
Ref. No METRIC C118 M6-M12 T&B (23Pc)	FBI0200014	"Taps (Taper, Second & Bottom): M6, M7, M8, M9, M10, M11, M12 Dies: 1" OD- M6 TO M12 Accessories: Tap Wrenches - 1nos. & Die stock - 1nos."
Ref. No METRIC 8 M3-M12 T&B (23Pc)	FBI0200015	"Taps (Taper, Second & Bottom): M3, M4, M5, M6, M8, M10, M12 Dies: 1" OD- M3 TO M12 Accessories: Tap Wrenches - 1nos. & Die stock - 1nos."
Ref. No C37 1/4-3/4 BSW T&B (24Pc)	FBI0200016	"Taps (Taper, Second & Bottom): 1/4", 5/16", 3/8", 7/16", 1/2", 5/8", 3/4" Dies: 1" OD- 1/4", 5/16", 3/8" & 1.1/2" OD - 7/16", 1/2", 5/8", 3/4" Accessories: Tap Wrenches - 1nos. & Die stock - 2nos."
Ref. No C37 1/4-3/4 BSF T&B (24Pc)	FBI0200017	"Taps (Taper, Second & Bottom): 1/4", 5/16", 3/8", 7/16", 1/2", 5/8", 3/4" Dies: 1" OD- 1/4", 5/16", 3/8" & 1.1/2" OD - 7/16", 1/2", 5/8", 3/4" Accessories: Tap Wrenches - 1nos. & Die stock - 2nos."



## Carbon Steel Hand Taps



### Tap and die case sets

Description	EDP No	Content
Ref. No C37 1/4-3/4 NF T&B (24Pc)	FBI0200018	"Taps (Taper, Second & Bottom): 1/4", 5/16", 3/8", 7/16", 1/2", 5/8", 3/4" Dies: 1" OD- 1/4", 5/16", 3/8" & 1.1/2" OD - 7/16", 1/2", 5/8", 3/4" Accessories: Tap Wrenches - 1nos. & Die stock - 2nos."
Ref. No C37 1/4-3/4 NC T&B (24Pc)	FBI0200019	"Taps (Taper, Second & Bottom): 1/4", 5/16", 3/8", 7/16", 1/2", 5/8", 3/4" Dies: 1" OD- 1/4", 5/16", 3/8" & 1.1/2" OD - 7/16", 1/2", 5/8", 3/4" Accessories: Tap Wrenches - 1nos. & Die stock - 2nos."
Ref. No INCHES 9 1/4-3/4 BSW T&B (28Pc)	FBI0200020	"Taps (Taper, Second & Bottom): 1/4", 5/16", 3/8", 1/2", 9/16", 5/8", 11/16", 3/4" Dies: 1" OD- 1/4", 5/16", 3/8" & 1.1/2" OD - 9/16", 5/8", 11/16", 3/4" Accessories: Tap Wrenches - 2nos. & Die stock - 2nos."
Ref. No INCHES 9 1/4-3/4 BSF T&B (28Pc)	FBI0200021	"Taps (Taper, Second & Bottom): 1/4", 5/16", 3/8", 1/2", 9/16", 5/8", 11/16", 3/4" Dies: 1" OD- 1/4", 5/16", 3/8" & 1.1/2" OD - 9/16", 5/8", 11/16", 3/4" Accessories: Tap Wrenches - 2nos. & Die stock - 2nos."
Ref. No INCHES 9 1/4-3/4 NC T&B (28Pc)	FBI0200022	"Taps (Taper, Second & Bottom): 1/4", 5/16", 3/8", 1/2", 9/16", 5/8", 11/16", 3/4" Dies: 1" OD- 1/4", 5/16", 3/8" & 1.1/2" OD - 9/16", 5/8", 11/16", 3/4" Accessories: Tap Wrenches - 2nos. & Die stock - 2nos."
Ref. No C31 1/8-1/2 BSW T&B (24Pc)	FBI0200023	"Taps (Taper, Second & Bottom): 1/8", 3/16", 1/4", 5/16", 3/8", 7/16", 1/2" Dies: 13/16" OD- 1/8", 3/16" & 1" OD - 1/4", 5/16", 3/8", 7/16", 1/2" Accessories: Tap Wrenches - 1nos. & Die stock - 2nos."
Ref. No C82 1/4-1/2 BSW T&B (17Pc)	FBI0200024	"Taps (Taper, Second & Bottom): 1/4", 5/16", 3/8", 7/16", 1/2" Dies: 1" OD- 1/4", 5/16", 3/8", 7/16", 1/2" Accessories: Tap Wrenches - 1nos. & Die stock - 1nos."
Ref. No C82 1/4-1/2 BSF T&B (17Pc)	FBI0200025	"Taps (Taper, Second & Bottom): 1/4", 5/16", 3/8", 7/16", 1/2" Dies: 1" OD- 1/4", 5/16", 3/8", 7/16", 1/2" Accessories: Tap Wrenches - 1nos. & Die stock - 1nos."
Ref. No C82 1/4-1/2 NF T&B (17Pc)	FBI0200026	"Taps (Taper, Second & Bottom): 1/4", 5/16", 3/8", 7/16", 1/2" Dies: 1" OD- 1/4", 5/16", 3/8", 7/16", 1/2" Accessories: Tap Wrenches - 1nos. & Die stock - 1nos."
Ref. No C82 1/4-1/2 NC T&B (17Pc)	FBI0200027	"Taps (Taper, Second & Bottom): 1/4", 5/16", 3/8", 7/16", 1/2" Dies: 1" OD- 1/4", 5/16", 3/8", 7/16", 1/2" Accessories: Tap Wrenches - 1nos. & Die stock - 1nos."
Ref. No C52 3/16-1/2 BSW T&B (20Pc)	FBI0200028	"Taps (Taper, Second & Bottom): 3/16", 1/4", 5/16", 3/8", 7/16", 1/2" Dies: 1" OD - 3/16", 1/4", 5/16", 3/8", 7/16", 1/2" Accessories: Tap Wrenches - 1nos. & Die stock - 1nos."
Ref. No C52 3/16-1/2 BSF T&B (20Pc)	FBI0200029	"Taps (Taper, Second & Bottom): 3/16", 1/4", 5/16", 3/8", 7/16", 1/2" Dies: 1" OD - 3/16", 1/4", 5/16", 3/8", 7/16", 1/2" Accessories: Tap Wrenches - 1nos. & Die stock - 1nos."
Ref. No C85 1/4-1" BSW T&B (32Pc)	FBI0200030	"Taps (Taper, Second & Bottom): 1/4", 5/16", 3/8", 7/16", 1/2", 5/8", 3/4", 7/8", 1" Dies: 1" OD- 1/4", 5/16", 3/8" & 1.1/2" OD - 7/16", 1/2", 5/8" & 2" OD- 3/4", 7/8", 1" Accessories: Tap Wrenches - 2nos. & Die stock - 3nos."
Ref. No C85 1/4-1" BSF T&B (32Pc)	FBI0200031	"Taps (Taper, Second & Bottom): 1/4", 5/16", 3/8", 7/16", 1/2", 5/8", 3/4", 7/8", 1" Dies: 1" OD- 1/4", 5/16", 3/8" & 1.1/2" OD - 7/16", 1/2", 5/8" & 2" OD- 3/4", 7/8", 1" Accessories: Tap Wrenches - 2nos. & Die stock - 3nos."
Ref. No C85 1/4-1" NF T&B (32Pc)	FBI0200032	"Taps (Taper, Second & Bottom): 1/4", 5/16", 3/8", 7/16", 1/2", 5/8", 3/4", 7/8", 1" Dies: 1" OD- 1/4", 5/16", 3/8" & 1.1/2" OD - 7/16", 1/2", 5/8" & 2" OD- 3/4", 7/8", 1" Accessories: Tap Wrenches - 2nos. & Die stock - 3nos."
Ref. No C85 1/4-1" NC T&B (32Pc)	FBI0200033	"Taps (Taper, Second & Bottom): 1/4", 5/16", 3/8", 7/16", 1/2", 5/8", 3/4", 7/8", 1" Dies: 1" OD- 1/4", 5/16", 3/8" & 1.1/2" OD - 7/16", 1/2", 5/8" & 2" OD- 3/4", 7/8", 1" Accessories: Tap Wrenches - 2nos. & Die stock - 3nos."



## Carbon Steel Hand Taps



### Adjustable tap wrenches (forged steel)

Tap Capacity		Overall Nominal Length		EDP No.
Inch	mm	Inch	mm	
1/16"- 1/4"	2 - 6	6- 1/4"	172	FBN2200009
1/8"- 1/2"	3 - 12	8-1/16"	205	FBN2200010
5/32"- 3/8"	4 - 10	8-1/16"	205	FBN2200011
3/16"- 1/2"	5 - 12	10-3/16"	258	FBN2200012
3/16"-5/8"	5 - 16	10-1/4"	264	FBN2200013
1/4"-3/4"	6 - 20	13-3/4"	350	FBN2200014
5/16"-1"	8 - 25	17-1/4"	435	FBN2200015
3/8"-1"	10 - 25	17-5/16"	440	FBN2200016
3/4"-1.1/2"	18 - 38	27"	685	FBN2200017
1"-2"	25 - 50	34-1/2"	875	FBN2200018

### T-Handle tap wrenches

Tap Capacity		Overall Nominal Length		EDP No.
Inch	mm	Inch	mm	
1/16"-5/32"	2 - 4	2-3/8"	60	FBN2200019
5/32"-1/4"	4 - 6	2-11/16"	69	FBN2200020
3/16"-5/16	5 - 8	2-5/32"	80	FBN2200021
1/4"-1/2	6 - 12	3-1/2"	88	FBN2200022

### T-Handle tap wrenches ratchet type

Tap Capacity		Overall Nominal Length		EDP No.
Inch	mm	Inch	mm	
5/32"-1/4"	4 - 6	2-11/16"	69	FBN2200023
1/4"-1/2"	6 - 12	3-1/2"	88	FBN2200024
5/32"-1/4"	4 - 6	10-1/4"	260	ABM000022
1/4"-1/2"	6 - 12	12"	305	ABM000023

### Die stocks

Tap Capacity		Overall Nominal Length		EDP No.
Inch	mm	Inch	mm	
13/16"	20	6-3/4"	170	FBN2200001
1"	25	8-3/4"	222	FBN2200002
1.5/16"	33	10"	254	FBN2200003
1.1/2"	38	12-1/2"	317	FBN2200004
2"	50	15-9/16"	395	FBN2200005
2.1/4"	57	16.1/2"	420	FBN2200006
2.1/2"	63	19"	480	FBN2200007
3"	75	22-1/2"	572	FBN2200008
4"	100	35"	890	FBN2200028

## Carbon steel taps nomenclature

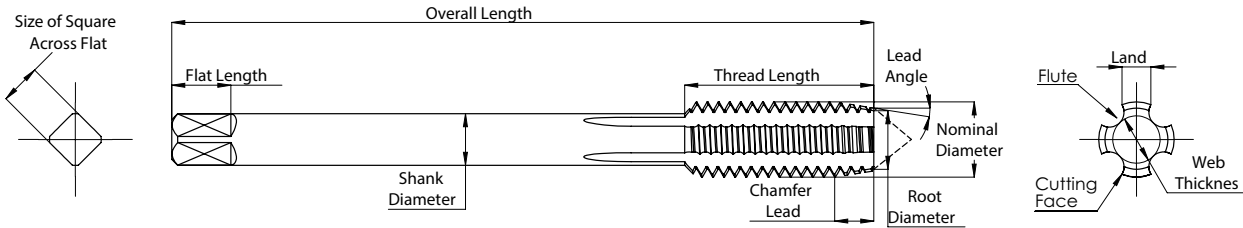

## Carbon taps application

### AUTOMOBILE INDUSTRY

- Cylinder liner and cylinder head manufacturers
- General purpose applications in small workshops, garages, tool rooms and maintenance departments
- Motor cycle body frames: spatter cleaning and removing paint from threaded portion.
- Carburetor and speedometer manufacturers
- High speed steel dies are used in removing paint from threaded portion in rear axles of cars, trucks, buses, etc.
- Dies are used by gas valve manufacturers.

### ENGINEERING INDUSTRY

- Air compressors / blower manufacturers
- Cooling towers and heat exchangers
- Brass component manufacturers
- Pipe and pipe fitting manufacturers.
- Sheet metal industry
- Thread dressing of diesel engine components
- Steel furniture manufacturers
- Steel window manufacturers
- Bus and truck body building workshops
- Textile industry
- Electrical industry

### HOUSEHOLD APPLIANCE MANUFACTURERS

- Pressure cookers
- Fans, air coolers, air conditioners
- Flour mills, mixers and grinders